

Preface

Publish statement

Thank you for purchasing this series UPS.

This series UPS is an intelligent, Single phase in Single phase out, high frequency online UPS designed by our R&D team who is with years of designing experiences on UPS. With excellent electrical performance, perfect intelligent monitoring and network functions, smart appearance, complying with EMC and safety standards, The UPS meets the world's advanced level.

Read this manual carefully before installation

This manual provides technical support to the operator of the equipment.

Contents

1. Safety	1
1.1 Safety	1
1.2 Symbol Description	2
2. Product Introduction	4
2.1 The appearance of the product	4
2.2 The principle of the product.....	8
2.3 Product Category	8
3. Installation	9
3.1 Unpacking and inspection	9
3.2 Installation note	9
3.3 UPS input and output connection.....	10
3.4 Connection of the UPS communication cables	11
3.5 Parallel Card (Optional).....	12
3.6 External battery connection (for extend model only)	13
4. Panel display, operation and running	16
4.1 Start up and turn off UPS	16
4.1.1 Start up operation.....	16
4.1.2 Turn off operation.....	16
4.2 Faceplate display	17
4.2.1 Faceplate display illumination.....	17
4.2.2 LCD display	18
4.3 Parameters setting.....	20
4.3.1 Mode setting	20
4.3.2 Output voltage class setting	21
4.3.3 Output frequency setting	21
4.3.5 Battery quantity setting.....	23
4.3.6 Bypass Volt-Hi setting.....	23
4.3.7 Bypass Volt-Lo setting	24
4.3.8 Buzzer Mute Setting.....	25
4.3.9 Battery Test Setting.....	25
4.3.10 Parallel ID setting	27
4.3.11 Parallel quantity setting.....	27
4.3.12 Parallel redundancy quantity setting	28
4.4 Alarm Information.....	29
5.1 Battery maintenance	30
6.1 Troubleshooting	32
6.2 EMC standard/Safety standard	32

1. Safety

This chapter mainly introduces the safety signs and security considerations of 6K/10K series high frequency online ups. Before any operation of equipment, you should read the content of this chapter carefully.

1.1 Safety

There exists dangerous voltage and high temperature inside the UPS. During the installation, operation and maintenance, please abide the local safety instructions and relative laws, otherwise it will result in personnel injury or equipment damage. Safety instructions in this manual act as a supplementary for the local safety instructions. Our company will not assume the liability that caused by disobeying safety instructions.



Our company will not assume the liability that caused by disobey of safety instructions. Please note the following:

1. Don't use the UPS when the actual load exceeds the rated load.
2. There are high-capacity batteries in the standard type UPS. You must not open the enclosure or it will lead to electric shock. If it needs internal maintenance or battery replacement, please send it to the designated site.
3. Internal short-circuit of the UPS will cause electric shock or fire. So don't place the containers equipped with liquid on the top of the UPS so as not to cause danger of electric shock and so on.
4. Don't put the UPS in a place with high temperature or humidity as well as the corrosive gas, much dust.
5. Keep good air circulation between in-vent on front panel and out-vent on back panel.
6. Avoid direct sunlight or near heat-dispensed objects.
7. In case that the smoke appears on the UPS, please cut off the power as soon as possible and contact the dealer service site.

1.2 Symbol Description

The safety symbols cited in this manual are shown in table 1-1, which are used to inform readers of safety issues that should be obeyed when installation, operation and maintenance.

Fig.1-1 Symbol meanings

Safety Symbol	Indication
	Attention
	Static discharge sensitive
	Electric shock

There are three levels of safety grade: Dangerous, Warning and Attention. The remark is on the right side of the safety symbol, the detailed comments are shown as following:



Dangerous:

Indicate risk of serious injury or death or seriously damage of the equipment.



Warning:

Indicate risk of serious injury or damage of the equipment.











Attention:

Indicate risk of injury or damage of the equipment.

Description of Commonly Used Symbols

Some or all of the following symbols may be used in this manual. It is advisable to familiarize yourself with them and understand their meaning:

Symbol and Explanation			
Symbol	Explanation	Symbol	Explanation
	Alert you to pay special attention		Direct current source (DC)
	Caution of high voltage		Protective ground
	Turn on or turn off the UPS		Recycle
	Alternating current source (AC)		Do not dispose with ordinary trash

2. Product Introduction

2.1 The appearance of the product

2.1.1 6K/10K-H

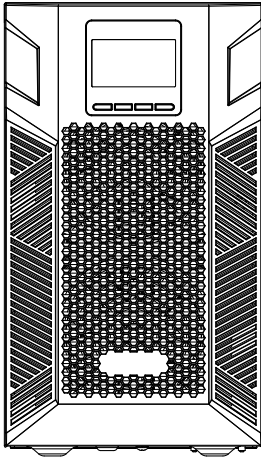

Fig.1 6/10kVA(H) Front Panel view

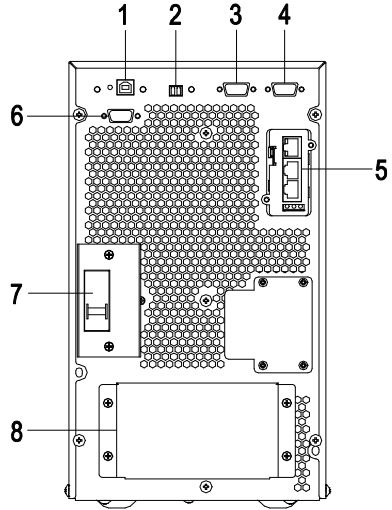

Fig.2 6/10kVA(H) Rear Panel view (without Maintenance)

- 1) USB
- 2) EPO
- 3) Parallel port 1
- 4) Parallel port 2
- 5) Intelligent slot
- 6) RS232
- 7) Input switch
- 8) Terminals (covered)

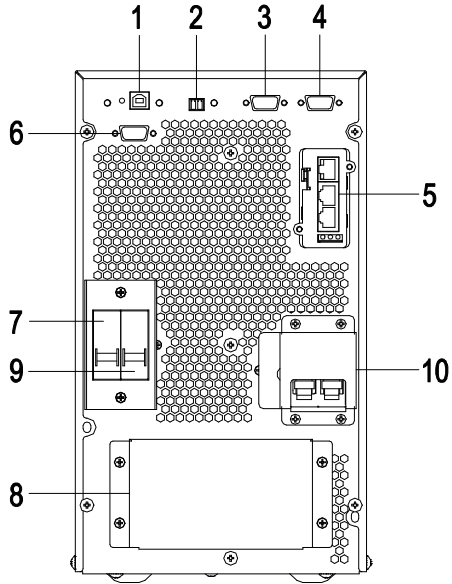

Fig.3 6/10kVA(H) Rear Panel view(with Maintenance)

- 1) USB
- 2) EPO
- 3) Parallel port 1
- 4) Parallel port 2
- 5) Intelligent slot
- 6) RS232
- 7) Input switch
- 8) Terminals (covered)
- 9) output switch
- 10) Maintenance bypass switch (covered)

2.1.2 6K/10K-S

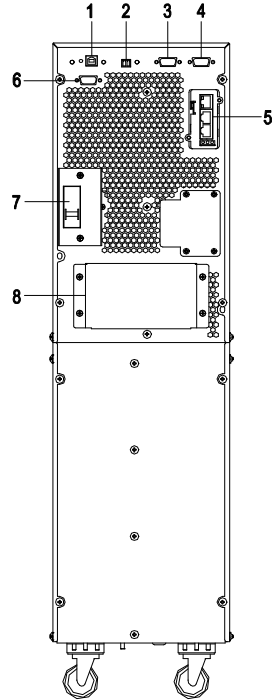
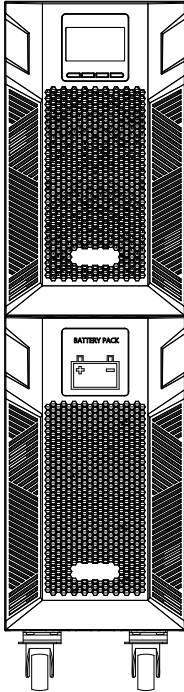

Fig.5 6/10kVA(S)Front Panel view Fig.6 6/10kVA(S)Rear Panel view(without Maintenance)

- 1) USB
- 2) EPO
- 3) Parallel port 1
- 4) Parallel port 2
- 5) Intelligent slot
- 6) RS232
- 7) Input switch
- 8) Terminals (covered)

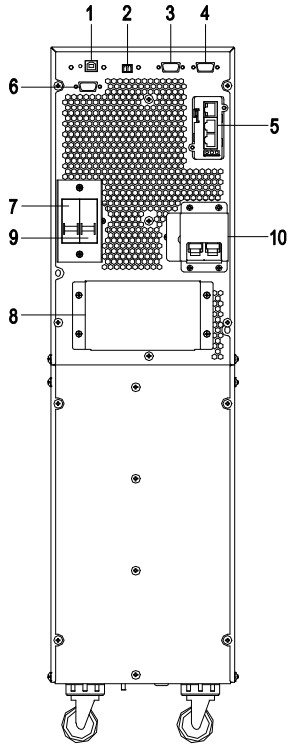

Fig.7 6/10kVA(S)Rear Panel view(with Maintenance)

- 1) USB
- 2) EPO
- 3) Parallel port 1
- 4) Parallel port 2
- 5) Intelligent slot
- 6) RS232
- 7) Input switch
- 8) Terminals (covered)
- 9) Output switch
- 10) Maintenance bypass switch (covered)

2.2 The principle of the product

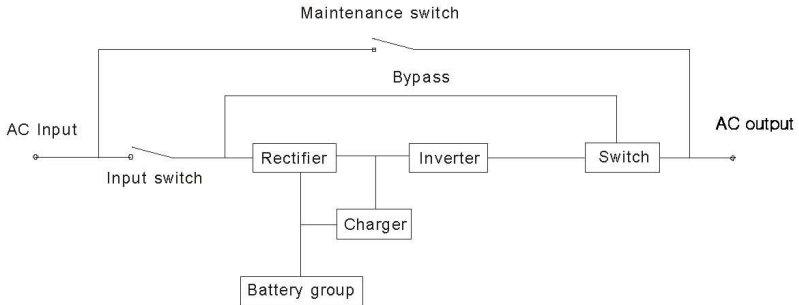

Fig. 2-1 UPS Principle Diagram

1. Input filter: Complete filtering the input AC utility power to provide the clean power for UPS.
2. AC/DC converter: Convert the filtered AC mains to DC and boost the DC for DC/AC inverter.
3. DC/DC booster: When the UPS works in battery mode, the circuit boosts the DC for DC/AC inverter.
4. DC/AC inverter: Convert the boosted DC to stable AC output.
5. Bypass: When overload or failure of inverting happen in the UPS, it transfers to bypass mode to supply power to loads.
6. Charger: Standard unit provides 1A; long backup unit provides 10A Max.
7. Battery: Sealed Lead Acid Battery.
8. Output filter: Complete filtering the output of the UPS to provide the clean power for loads.

2.3 Product Category

UPS Type		Remark
Standard unit	6kVA	Internal 16~20PCS(12V/PCS) batteries
	10kVA	Internal 16~20PCS(12V/PCS) batteries
Long backup unit	6kVA	External 16~20PCS(12V/PCS) batteries
	10kVA	External 16~20PCS(12V/PCS) batteries

3. Installation

3.1 Unpacking and inspection

1. Unpacking the UPS and check that whether it's damaged during the transportation. If damaged or some parts missing, don't start the machine and inform the carrier and franchiser.
2. Check the annex.
3. Check if the UPS is just what you wanted to purchase. You can affirm through inspecting the model number on rear panel of the UPS.

3.2 Installation note

Put the UPS at flat place next to the equipment.

Keep UPS at least 20cm from wall or equipment or other object. Don't block the ventilation holes of the UPS front panel and bottom part, so as to keep the ventilation in good conditions, avoid temperature of components inside getting high.

Keep the UPS away from high temperature, water, flammable gas, corrosive gas, dust, direct sunlight; explosive things don't lay the UPS outdoor

Install a double-pole joined actuator with more than 40A/63A (6kVA/10kVA) at the input L-N, in order to cut off the power when in emergency situation.

PDU is required to connect to the UPS output so as to weaken the affection between loads.

In order to fix the UPS, please lock its wheels by shifting the sheet on each wheel.

RCD load like computer, linear load and small inductive load can be connected to the UPS. Please contact dealer if other types of loads are required to connect.

For the sake of user and equipments, please be sure to take correct power configuration.

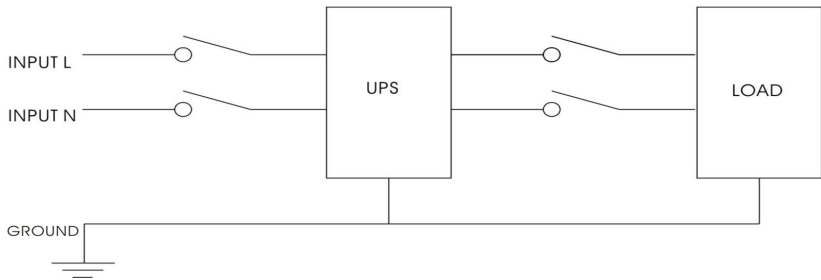

Fig.3-1 Correct power configuration

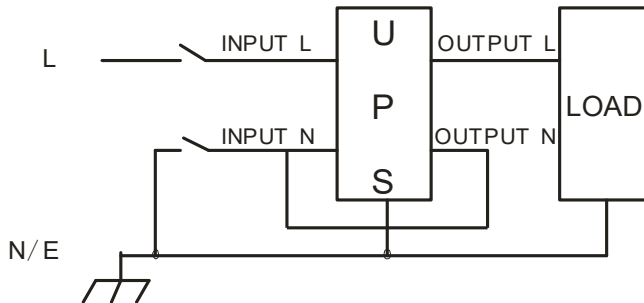

Fig.3-2 Wrong power configuration

3.3 UPS input and output connection

Minimum 10AWG copper wires are required for the 6kVA, and 8AWG for 10kVA, including input/output cables, battery cables.

- 1) Switch off all breakers before connecting cables
- 2) Remove the cover of the terminals, see Fig 2-3, following it to connect the cables

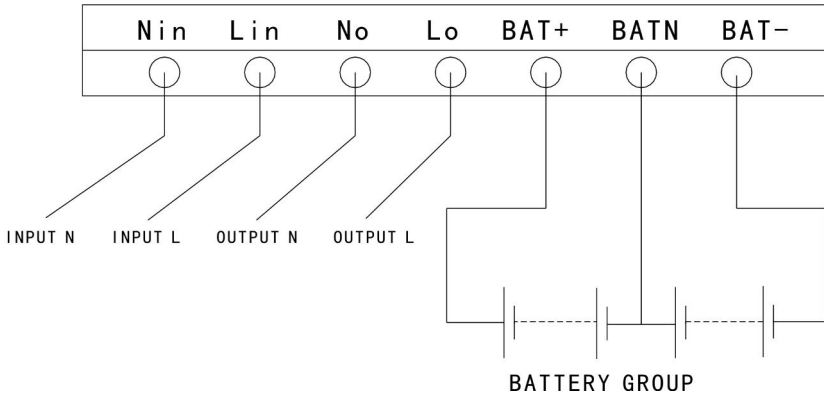

Fig.3-3 I/O terminals connection

CAUTION!

Terminators are required so as to ensure the connections are firm.

Don't reverse the input L and N.

Don't connect the UPS input to a wall outlet or the outlet will get burnt.

- 3) Connect the UPS output L, N, GND to L, N, GND of load via a PDU. Tighten the screws and shelter the terminals

3.4 Connection of the UPS communication cables

- 1) RS-232 or USB cable provided in accessories can be used to connect the UPS with PC
- 2) Follow steps below to install SNMP (if purchased):
 - A. Remove the cover of SNMP slot at UPS rear panel and keep it for further use.
 - B. Insert the SNMP card and tighten the screws
 - C. Connect the UPS with internet by network cable.
 - D. Refer to the SNMP manual provided to do SNMP setting.

3.5 Parallel Card (Optional)

Parallel installation steps as below:

- 1) Loosen the screws in the parallel card slot and remove the cover, please keep the cover for future use.
- 2) Insert the parallel card into the slot and tighten the screws.
- 3) Connect the UPS with parallel cables.

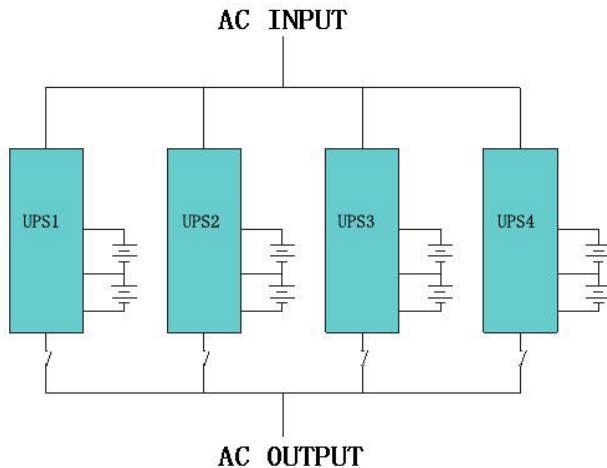

- 4) Connect all the outputs of the parallel UPS to one patch board before connect to the loads. See the picture as follows.
- 5) Start one UPS in turn and set parameters through LCD: working mode: parallel mode; parallel ID: setting ID in sequence; total numbers in parallel: according to the actual numbers; parallel redundancy sets: setting when redundancy requirement (See the Manual Chapter 4.3.1; 4.3.10; 4.3.11; 4.3.12 for more methods of parameter setting).
- 6) Start UPS at the same time or in turn, they will provide power supply to loads in parallel operation after finishing setting the ups. Additional, it can also be communicated and setted with PC through USB. See the steps as below.
1. Start up the UPS one by one, connect USB to the computer, start up software and manual are included in the CD-ROM.

2. Open the set up interface to set up relevant parameters as below:
 - ① Work mode, parallel operation;
 - ② Parallel ID: Set up the ID one by one;
 - ③ Parallel amount: set the amount in parallel.
3. After finishing setting up, the UPS can be started up at the same time or one by one. The UPS will work in parallel to supply power to the loads.



NOTICE: When the UPS in parallel, the input can be the same or different, but the output should be paralleled to one patch board.

3.6 External battery connection (for extend model only)

- 1) Make sure battery quantity complies with the specs (16/18/20 pieces of 12V battery in parallel) . Measure the voltage of battery bank after finishing connection and the battery voltage should be around 192/216/240Vdc.



NOTICE:

1. Don't mix batteries with different capacity, manufacturers and don't mix brand new and old batteries, either.
2. The standard setting of the battery is 16 pcs and battery capacity is 65AH(charge current is 6A).When connecting with 18 pcs or 20 pcs battery, please start up the UPS under AC mode, connect to the computer to set up battery number and capacity, the UPS will follow battery capacity to distribute charge current automatically (Max charge current is 10A)
- 2) The breaker on battery cabinet should be off.
- 3) Remove the cover of terminals, use multi-meter to make sure there is no DC voltage at the battery terminals of UPS.
- 4) Connect battery with positive pole, negative pole and common pole to battery connector (BAT+,BATN,BAT-) , don't reverse battery connection.

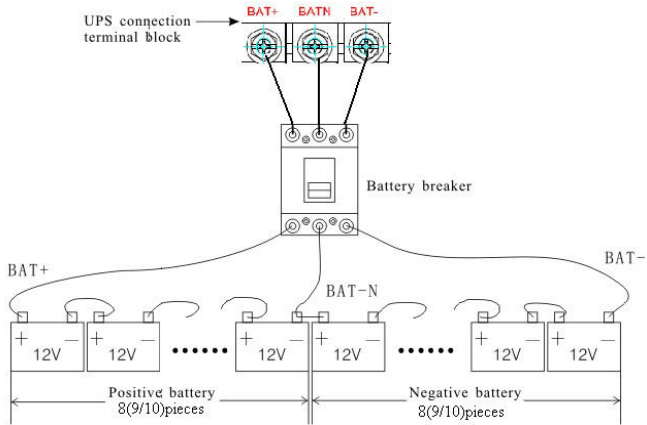

Fig.3-4 External battery connection



Warning:

- ★ Before installing battery, make sure that the UPS and breaker are all turned off. Remove all your metallic adornment such as finger ring, watch, and so on before connecting battery.
- ★ No anti-connection or short circuit between the battery anode and cathode forever. Red cable connect with battery anode “+” and black cable connect with cathode “-”.
- ★ Please use the screwdriver with insulating handle. Do not lay the tools or metallic goods on the battery.



Notice:

- ★ When using the external battery, It is best to use external battery cable which matches with the equipment.
- ★ When connecting load to UPS, first turn off load and then connect the power cable and finally turn on load one-by-one.
- ★ Inductance loads such as motor, fluorescent lamp, photocopier are strictly prohibited connecting to UPS to avoid damage.
- ★ Plug UPS on the special socket with over-current protection, the power socket that used should be connected with ground wire.
- ★ UPS is likely to have output voltage no matter whether the power input cable is plugged in mains input socket. If you wish UPS have no output, first break off the switch and then cancel the mains.

- ★ When connect laser printer, select the capacity of UPS according to the UPS start power because the startup power is higher.

4. Panel display, operation and running

The operation is simple, operators only need to read the manual and follow the operation instructions listed in this manual, no need any special training.

4.1 Start up and turn off UPS

4.1.1 Start up operation

1、 Turn on the UPS in Line mode

Once AC Power Cord is plugged in, the UPS will start automatically and the LCD display of the UPS will be lit on. You may view the data and set parameters on the LCD display as well as the LED display showing the status of the UPS.

2、 Turn on the UPS in Battery Mode

Press “ENTER/ON” on the front panel to start the UPS and in the meantime, the LCD display will light up. You may view the data and set parameters on the LCD display and the LED display of the UPS will show the latest status of the UPS.

4.1.2 Turn off operation

1、 Turn off the UPS in line mode (without batteries)

- a) Press and hold the ESC/OFF key for 2 seconds to turn off the inverter and the UPS is in Bypass mode now; on the contrary, you may press the hold the ENTER/ON key for 2 seconds in order to Change over back to inverter mode.
- b) To shut down (turn off) the UPS completely, you need to turn off the input switch.

2、 Turn off the UPS with connecting batteries

- a) Press and hold the ESC/OFF key for 2 seconds to turn off the UPS.
- b) After UPS is turned off, all LED and LCD will be extinguished and there is no output.

Remarks: When the UPS is turned off from the inverter mode, it will discharge DC Bus to 80V, then shut down completely; therefore, sometimes, it takes more several seconds to complete.

4.2 Faceplate display

4.2.1 Faceplate display illumination

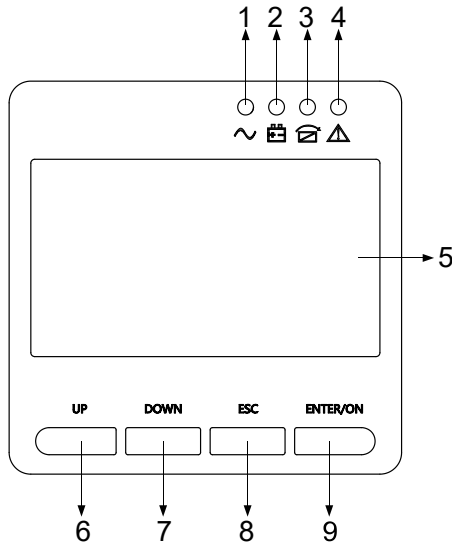

Fig.4-1 Overview of the operating panel of the UPS

- (1) INVERTER LED
- (2) BATTERY LED
- (3) BYPASS LED
- (4) ALARM LED
- (5) LCD display
- (6) UP button
- (7) DOWN button
- (8) ESC/OFF button
- (9) ENTER/ON button

4.2.2 LCD display

NOTICE! The display provides more functions than those described in this manual. There are 10 interfaces available in the LCD display:

ITEM	Interface Description	Content Displayed
01	Input	Voltage & Frequency
02	Output	Voltage & Frequency
03	Bat. +	Voltage & Current
04	Bat. -	Voltage & Current
05	Temperature	PFC/Internal temperature and ambient temperature
06	Load	Load
07	Bus voltage	Bus voltage \pm
08	Software version	DSP version of inverter software
09	Model	Model

1. When the UPS is connecting with the Utility or Battery at cold start mode, it shows as drawing below:

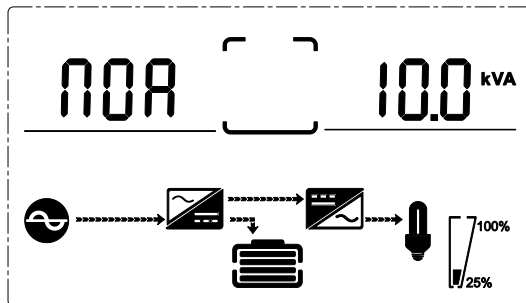

(1) Operational Status and mode

1) Operational Status and mode When the UPS at single mode, it shows “NOA” or “ECO” or “CF”, but If the UPS at parallel mode, it shows “PAL” instead.

2) Press “DOWN” button, the UPS goes to next page as shown below.

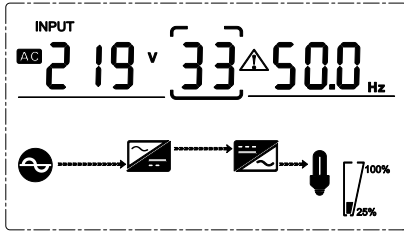

(2) Input voltage

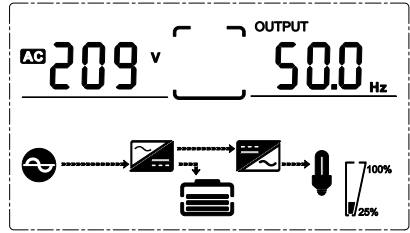

(3) Output voltage

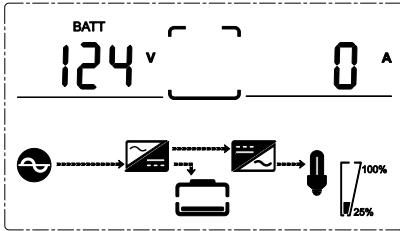

(4) Bat + voltage (Positive)

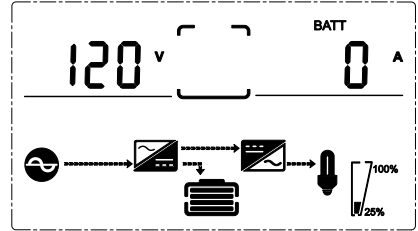

(5) Bat - voltage (Negative)

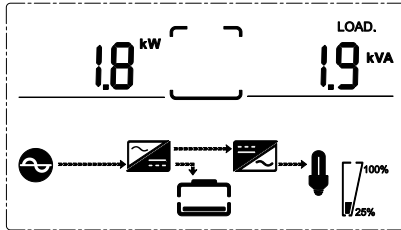

(6) Load

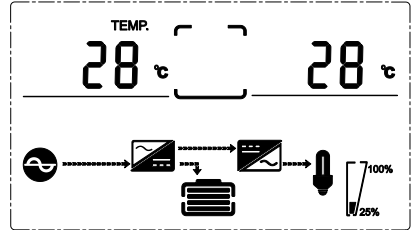

(7) PFC/ Ambient temperature up,
only shows the high temperature
Internal temperature (down)

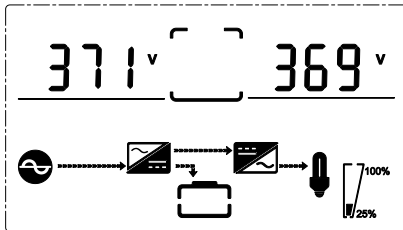

(8) Bus voltage

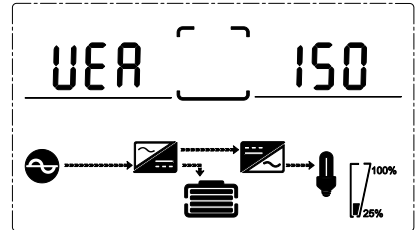

(9) Software version

4.3 Parameters setting

The setting function is controlled by 4 buttons (ENTER/ON, ESC/OFF, UP,DOWN): ENTER /ON---goes into the setting page and value adjustment; UP & DOWN ---for choosing different pages.

After the UPS turn ON, press buttons UP & DOWN for 3 seconds and then goes into the setting interface page. After finishing setting the parameter, press “ESC/OFF” button until exiting out of the current interface.

4.3.1 Mode setting

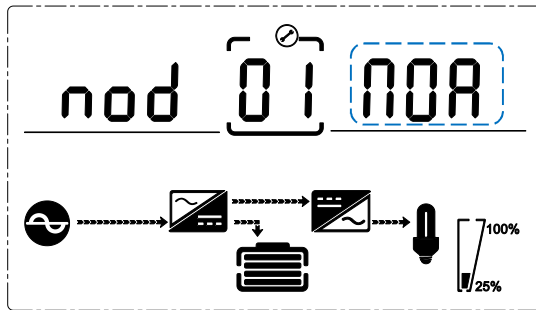

Mode setting (Note: Inside the broken-line is the flashing part.)

After ENTERing the setting menu, it's mode setting defaulted, and the mode setting line flashing as in above picture.

- Use button ENTER /ON to choose different mode. There are 4 different modes for setting: ECO, PAL, NOR,CF.
- Press UP & DOWN to exit the mode setting (save the mode setting), and goes to output voltage setting or parallel redundancy quantity setting.

4.3.2 Output voltage class setting

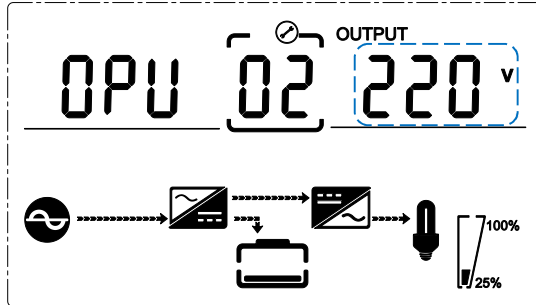

Output voltage setting

(Note: Inside the broken-line is the flashing part.)

When under the mode setting press DOWN or when under frequency setting press UP, it goes to the output voltage setting. The output voltage line flashes as in above picture.

- Use button ENTER/ON to choose the different output voltage. There are 4 different voltages---208,220, 230, 240.
- Press ESC/OFF button to exit the output voltage setting (save the output voltage setting) and goes to mode setting or frequency setting.

NOTE:When powered by inverter, it is necessary to turn off the inverter before setting voltage and frequency level.

4.3.3 Output frequency setting

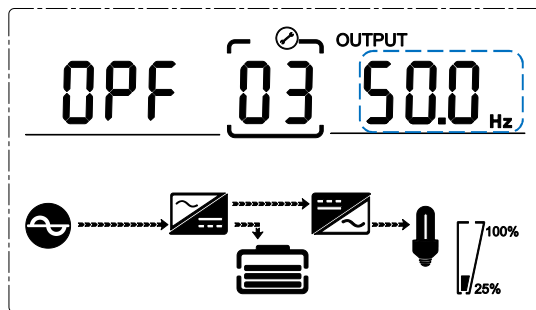

Frequency setting

(Note: Inside the broken-line is the flashing part.)

When under the output voltage setting press DOWN or when under battery capacity setting press UP, it goes to the frequency setting. The frequency line flashes as in above picture.

- Use button ENTER/ON to choose the different frequency. There are 2 different frequency---50/60Hz.
- Press ESC/OFF button to exit the frequency setting (save the frequency setting) and goes to output voltage setting or battery capacity setting.

Note: When powered by inverter, it is necessary to turn off the inverter before setting voltage and frequency level.

4.3.4 Battery capacity setting

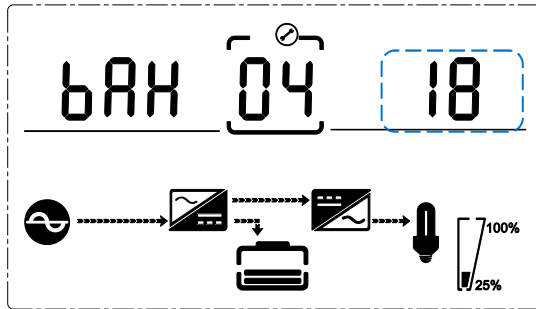

Battery capacity setting

(Note: Inside the broken-line is the flashing part.)

When under the frequency setting press DOWN or when under battery quantity setting press UP, it goes to the battery capacity setting. The battery capacity line flashes as in above picture.

- Use button ENTER/ON to choose the different battery capacity. Battery capacity range is 1-200Ah. (Note: long-press of UP or DOWM can adjustment battery capacity quickly)
- Press ESC/OFF button to exit the battery capacity setting (save the capacity setting) and goes to frequency setting or battery quantity setting.

4.3.5 Battery quantity setting

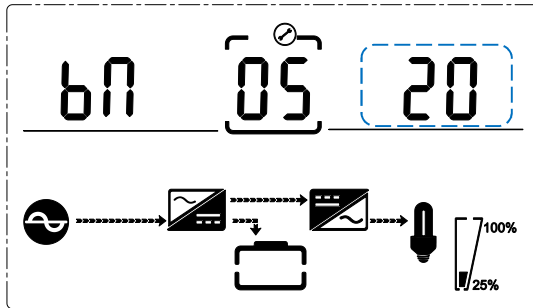

Battery quantity setting

(Note: Inside the broken-line is the flashing part.)

When under the battery capacity setting press DOWN or when under bypass voltage upper limit setting press UP, it goes to the battery quantity setting. The battery quantity line flashes as in above picture.

- Use button ENTER/ON to choose the different battery quantity. Battery quantity range is 16、18、20.
- Press ESC/OFF button to exit the battery quantity setting (save the battery quantity setting) and goes to battery capacity setting or bypass voltage upper limit setting.

4.3.6 Bypass Volt-Hi setting

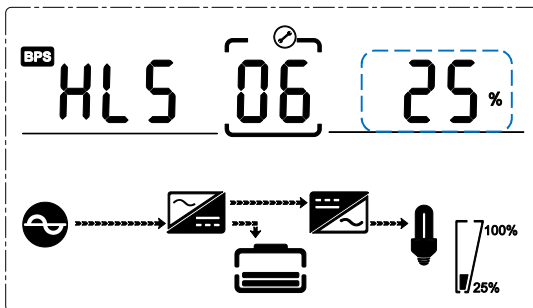

Bypass voltage upper limit setting

(Note: Inside the broken-line is the flashing part.)

When under the battery quantity setting press DOWN or when under bypass voltage lower setting press UP, it goes to the bypass upper limit setting. The bypass upper limit line flashes as in above picture.

- Use button ENTER/ON to set the different bypass voltage upper limit. The bypass voltage upper limit range is 5%,10%,15%,25%(25% only for 220V output).
- Press ESC/OFF button to exit the bypass voltage upper limit setting (save the bypass voltage upper limit setting) and goes to battery quantity setting or bypass voltage lower limit setting.

4.3.7 Bypass Volt-Lo setting

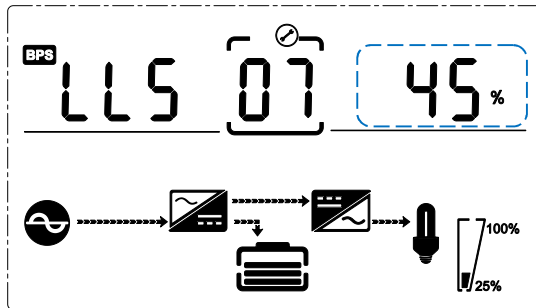

Bypass voltage lower limit setting
(Note: Inside the broken-line is the flashing part.)

When under the bypass voltage upper limit setting press DOWN or when under parallel ID setting press UP, it goes to the bypass lower limit setting. The bypass lower limit line flashes as in above picture.

- Use button ENTER/ON (to set the different bypass voltage lower limit. The bypass voltage lower limit range is 20%,30%,45%.
- Press ESC/OFF button to exit the bypass voltage lower limit setting (save the bypass voltage lower limit setting) and goes to bypass upper limit setting or parallel ID setting.

4.3.8 Buzzer Mute Setting

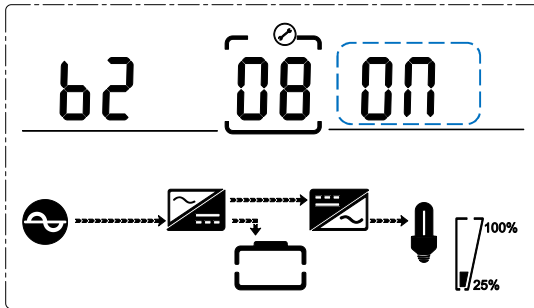

Buzzers mute setting (Note: flashing part in dashed box)

Press DOWN under bypass voltage lower limit setting or press UP under the parallel ID setting can ENTER the buzzer setting. Now the setting status is flashing as the Figure shows (note: on=mute; off= no mute). When press, it shows the mute cycle setting, the selection includes ON and OFF. (Press the up button or down button can exit the mute setting (save the mute setting status) and switch to bypass voltage lower limit setting or parallel ID setting (note: when in stand-alone mode, press down button to exit and save the settings, then the settings is completed for stand-alone unit).

4.3.9 Battery Test Setting

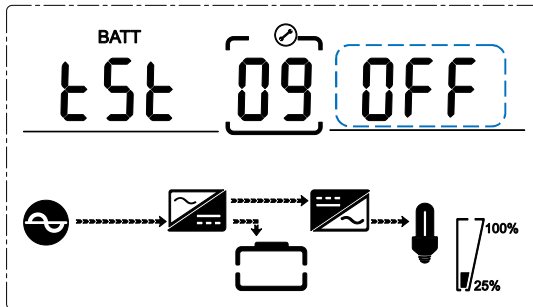

Battery self-test setting

This page is the introduction to the Battery self-test setting. The default Settings is "OFF" when the UPS has no need of the battery self-test

function. When turn to “ON”, batteries can do the self-test automatically per 30 days. Three kinds of Battery Self-test Time can be chose as below.

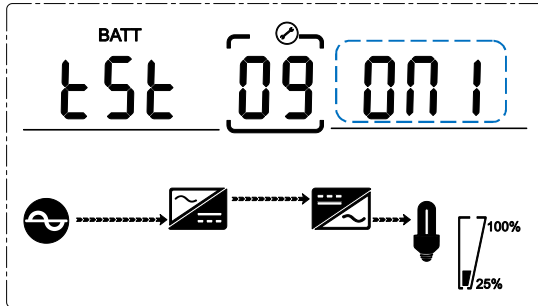

When choosing On1, UPS can transfer to Battery Mode automatically per 30 days. And the Battery Self-test Time is 10 seconds.

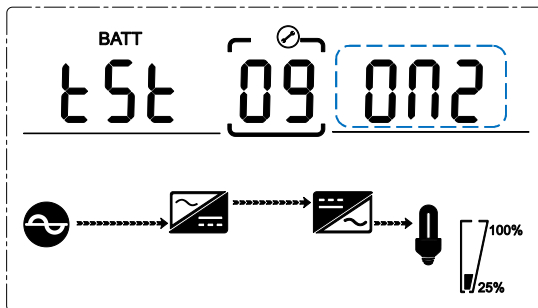

When choosing On2, UPS can transfer to Battery Mode automatically per 30 days. And the Battery Self-test Time is 10 minutes.

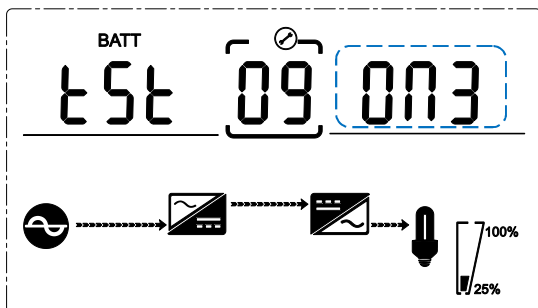

When choosing On3, UPS can transfer to Battery Mode automatically per 30 days. And the Battery Self-test Time is EOD.

4.3.10 Parallel ID setting

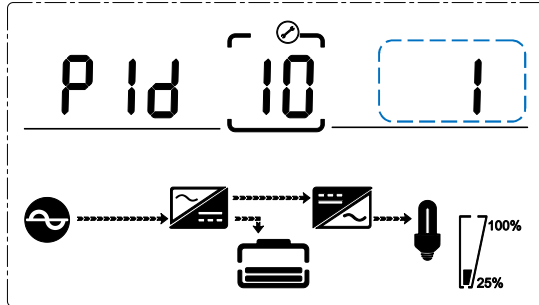

Parallel ID setting

(Note: Inside the broken-line is the flashing part.)

When under the bypass voltage lower limit setting press DOWN or when under parallel quantity setting press UP, it goes to the parallel ID setting. The parallel ID flashes as in above picture.

- Use button ENTER/ON to set the different parallel ID. The parallel ID range is 1~4.
- Press ESC/OFF button to exit the parallel ID setting (save the parallel ID setting) and goes to bypass lower limit setting or parallel quantity setting.

NOTICE! Parallel cable cannot be connected when setting the parallel parameters.

4.3.11 Parallel quantity setting

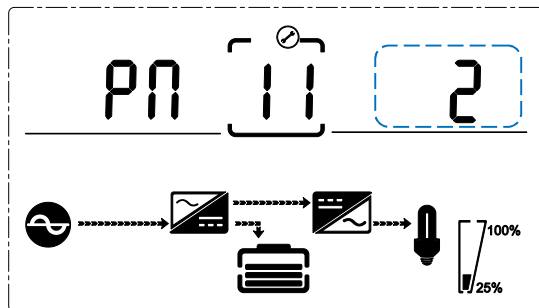

Parallel quantity setting

(Note: Inside the broken-line is the flashing part.)

When under the parallel ID setting press DOWN or when under parallel redundancy quantity setting press UP, it goes to the parallel quantity setting. The parallel quantity flashes as in above picture.

- Use button ENTER/ON to set the parallel quantity. The parallel quantity range is 2~4.
- Press ESC/OFF button to exit the parallel quantity setting (save the parallel quantity setting) and goes to parallel ID setting or parallel redundancy quantity setting.

4.3.12 Parallel redundancy quantity setting

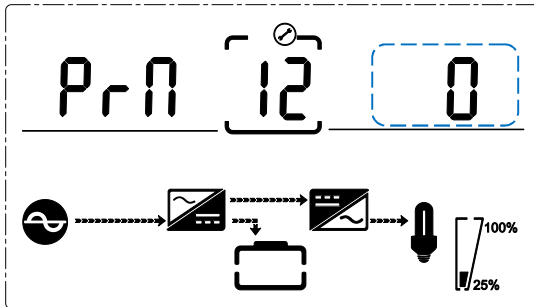

Parallel redundancy quantity setting
(Note: Inside the broken-line is the flashing part.)

When under the parallel quantity setting press DOWN, it goes to the parallel redundancy quantity setting. The parallel redundancy quantity flashes as in above picture.

- Use button ENTER/ON to set the parallel redundancy quantity. The parallel redundancy quantity range is 0~1
- Press UP& DOWN to go to parallel quantity setting, or ESC/OFF button to exit the mode setting. Then UPS LCD panel setting is accomplished.

4.4 Alarm Information

Item	UPS Alarm Warning	Buzz	LED
1	Rectifier Fault	Beep continuously	Fault LED lit
2	Inverter fault(Including Inverter bridge is shorted)	Beep continuously	Fault LED lit
3	Inverter Thyristor short	Beep continuously	Fault LED lit
4	Inverter Thyristor broken	Beep continuously	Fault LED lit
5	Bypass Thyristor short	Beep continuously	Fault LED lit
6	Bypass Thyristor broken	Beep continuously	Fault LED lit
7	Fuse broken	Beep continuously	Fault LED lit
8	Parallel relay fault	Beep continuously	Fault LED lit
9	Fan fault	Beep continuously	Fault LED lit
10	Reserve	Beep continuously	Fault LED lit
11	Auxiliary power fault	Beep continuously	Fault LED lit
12	Initialization fault	Beep continuously	Fault LED lit
13	P-Battery Charger fault	Beep continuously	Fault LED lit
14	N-Battery Charger fault	Beep continuously	Fault LED lit
15	DC Bus over voltage	Beep continuously	Fault LED lit
16	DC Bus below voltage	Beep continuously	Fault LED lit
17	DC bus unbalance	Beep continuously	Fault LED lit
18	Soft start failed	Beep continuously	Fault LED lit
19	Rectifier Over Temperature	Twice per second	Fault LED lit
20	Inverter Over temperature	Twice per second	Fault LED lit
21	Reserve	Twice per second	Fault LED lit
22	Battery reverse	Twice per second	Fault LED lit
23	Cable connection error	Twice per second	Fault LED lit
24	CAN comm. Fault	Twice per second	Fault LED lit
25	Parallel load sharing fault	Twice per second	Fault LED lit
26	Battery over voltage	Once per second	Fault LED blinking
27	Mains Site Wiring Fault	Once per second	Fault LED blinking
28	Bypass Site Wiring Fault	Once per second	Fault LED blinking
29	Output Short-circuit	Once per second	Fault LED blinking
30	Rectifier over current	Once per second	Fault LED blinking
31	Bypass over current	Once per second	BPS LED blinking

Item	UPS Alarm Warning	Buzz	LED
32	Overload	Once per second	INV or BPS blinking
33	No battery	Once per second	BATTERY blinking
34	Battery under voltage	Once per second	BATTERY blinking
35	Battery low pre-warning	Once per second	BATTERY blinking
36	Internal Communication Error	Once per second	Bypass LED lit
37	DC component over limit.	Once per 2 seconds	INV blinking
38	Parallel Overload	Once per 2 seconds	INV blinking
39	Mains volt. Abnormal	Once per 2 seconds	BATTERY LED lit
40	Mains freq. abnormal	Once per 2 seconds	BATTERY LED lit
41	Bypass Not Available		BPS blinking
42	Bypass unable to trace		BPS blinking
43	Inverter on invalid		
44	Reserve		
45	EPO	Beep continuously	Fault LED lit



NOTICE:

The following process must be performed if UPS is connected with generator:

- First turn on generator, after it runs stably connect output power of generator to UPS input terminal, then turn on UPS. After UPS turned on, please connect load one-by-one.
- It is recommended that the generator capacity is as twice as UPS rated capacity.

5. Maintenance

UPS use in the appropriate environment (see 3.2 installation considerations) can be free maintenance or less maintenance.

5.1 Battery maintenance

1. It is recommended that the batteries are manually charged or discharged

Once every three or four months if the UPS has not been used for a long time or the power is long-term uninterrupted. The battery will be fully discharge to low-voltage protection shutdown. Then it needs to be fully charged at once.

2. In high temperature area, batteries should be manually charged and discharged once every two months. The process is the same as that said above.
3. Under normal circumstances of using, the battery working life is three to five years. If you find that the battery do not act well such as obviously shortening of backup time, too much imbalance on battery voltage and so on, the battery should be replaced as soon as possible, which must be performed by qualified personnel.
4. When replace battery, it is recommended to change battery all together instead of changing separately.



NOTICE:

- ★ Before replacing batteries, first please turn off the UPS and break off the mains. Remove your metallic adornment such as finger ring, watch and so on.
- ★ When replace batteries, please use the screwdriver with insulating handle. Do not lay the tools or metallic goods on the battery.
- ★ Never reverse or short circuit between the battery anode and cathode.

6. Troubleshooting and performance of the product

1. In case the UPS can not work normally, it might be wrong in installation, wiring or operation. Please check these aspects first. If you need help, contact our service department, the following messages should be provided for analysis:
 - UPS MODEL and SERIAL NO.
 - Date of fault happened
 - Detailed description of the problem (include indicator statements on panel)

6.1 Troubleshooting

When the fault occurs, firstly, perform troubleshooting by referring to the troubleshooting table. If the fault still exists, please contact the franchiser.

Fault	Cause	Solution
Battery LED flashes	Battery low voltage or battery disconnected	Check UPS battery, connect battery well, if battery damaged, replace it
Mains normal, but UPS has no input	UPS input breaker open circuit	Press the breaker for reset
Short back up time	Battery not fully charged	Keep UPS connecting with mains power for more than 8 hours, recharge battery
	UPS overload	Check the usage of loads, remove some redundant devices
	Battery aged	When replace battery, contact franchiser to get battery and relative assembly
No AC power, UPS can't startup after pressing the ON key	Press the ON key for a short time	Press and hold the ON key for more than one second to start the UPS
	UPS has no battery connected or battery voltage low and too many loads connected	Connect UPS battery well, if battery voltage low, please turn off UPS and remove some loads, then start UPS
	Fault occurs inside UPS	Contact supplier for servicing

6.2 EMC standard/Safety standard

- ◆ Our products are manufactured according to the following EMC international grade standard and has passed the CE authentication:

EMC standard number	Safety standard number
IEC62040-2	IEC62040— 1
IEC61000-4-2	GB4943-2005
IEC61000-4-3	
IEC61000-4-4	
IEC61000-4-5	

6.3 Product Performance

Type		6KVA、10KVA	6KVA、10KVA	6KVA、10KVA
Capacity		4.8KW、8KW	5.4KW、9KW	6KW、10KW
AC INPUT	Input	Single phase & Ground		
	Power factor	≥ 0.99(input THDV ≤1%)		
	Rated voltage	220Vac / 230Vac / 240Vac		
	Rated frequency	50Hz/60Hz Automatically selected		
	Voltage range	120~276Vac		
	Frequency range	45~65Hz		
	Bypass voltage range	220Vac max: default +25% (+10% ,+15%, 20% , 25%)		
		230Vac max: default +20% (+10% ,+15%, 20%)		
		240Vac max: default +15% (+10% ,+15%)		
	Bypass frequency range	±1%、±2%、±4%、±5%、±10%		
THDI	≤3% (100% liner load, input THDV ≤1%)			
	≤5% (100% non liner load, input THDV ≤1%)			
BATTERY	Battery number	16/18/20 Pcs. Can be set		
	Battery type	VRLA		
	Charge model	Boost charge or float charge auto switch		
	Charge time	Boost charge up to 20Hr(Max)		
	Charge current (MAX.)	10A(H) 1A(S)		
AC OUTPUT	Output type	Single phase & Ground		
	Voltage regulation	±1.0%		
	Voltage distortion(THD)	less than 2% at 100% liner load		
		less than 5% at 100% non-liner load		
Rated voltage	220V/230V/ 240Vac can be setted			

AC OUTPUT	Frequency regulation	±0.1% (stand alone)
		±0.25% (parallel operation)
	Frequency	Utility mode: tracking mains frequency
		Battery mode: 50Hz/60Hz
	Frequency track speed	1Hz/s (stand alone)
		0.5Hz/s (parallel operation)
	load capacity (Mains, drop a level in battery mode) (PF0.8/0.9)	105 % ~ 110 %, lasts 1 hour
		110% ~ 125%, lasts 10 minutes
		125% ~ 150%, lasts 1 minute
		> 150%, switch to bypass immediately
	load capacity (Mains, drop a level in battery mode) (PF1.0)	105% ~ 110%, lasts 10 minutes
		110% ~ 130%, lasts 1 minute
		> 130%, switch to bypass immediately
	Overload for bypass	> 95%, can not inverter-fed
		Load for a long time when rated output current under 125%
Bypass load capacity is controlled by bypass circuit breaker, tripping when circuit breaker operating current.		
Crest factor	3:1	
Efficiency at AC	92%	
Dynamic respond	± 5.0% (100% balance load)	
	≤5% in a cycle	
Inverter output current limit	When current instantaneous value is 2 ~ 3 times of rated current peaks (1.414 * rated power / (3 * 220)), the inverter will be conducted in each pulse current limit protection.	
DC component	≤200mV	
Switch time	Between Normal and battery mode	0ms
	Between inverter and bypass	0ms
		< 15ms (50Hz), < 13.33ms (60Hz)

Noise	<55dB (1m)
Display	LED+LCD
Safety	Meeting IEC62040-1, GB4943
Max input voltage	320Vac, 1 hour (static)
EMI	Conduction : IEC 62040-2
	Radiation : IEC 62040-2
	Harmonics : IEC 62040-2
EMS	IEC 62040-2
Isolation resistance	> 2MΩ (500Vdc)
Isolation intension	2820Vdc, <3.5mA, 1min
Surge	Meeting IEC60664-1 1.2/50uS+8/20uS 6kV/3kA.
Protection	IP20

◆ Work Environment

Model	6kVA-10kVA series
Temperature	0°C~40°C
Relative	0~95% non-condensing
Altitude	<1500m. when >1500m, lower the rated power for

◆ Mechanical Specification

Mechanical Characteristics			
UPS TYPE		Long backup unit	Standard unit
Height	mm	330	720
Width	mm	191	191
Depth	mm	460	460
Net weight	kg	6K/10K:11/12	6K/10K:60/61

Note: 16 pcs. 7-9Ah Battery can be installed inside of standart UPS.
External battery Cabinet or Rack must be used for higher quantity
and capacity of batteries.

Appendix 1 USB communication port definition

Definition of Male port:

1	2
4	3

Pin 1 VCC , Pin 2 D-
pin 3 D+ , Pin 4 GND

Application: use UPSilon2000 Power Management software

Available functions of the USB

- Monitor UPS power status
- Monitor UPS alarm info
- Monitor UPS running parameters
- Timing off/on setting

Appendix 2 RS232 communication port definition

Definition of Male port:

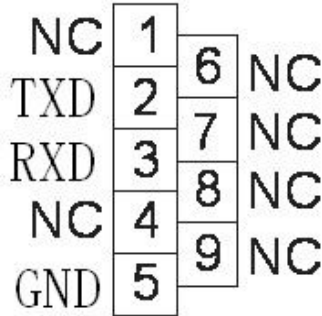

Connection between PC RS232 port and UPS RS232 port:

PC RS232 port	UPS RS232 port	
Pin 2	Pin 2	UPS send, PC receive
Pin 3	Pin 3	PC send, UPS receive
Pin 5	Pin 5	ground

Available function of RS232:

- ◆ Monitor UPS power status.
- ◆ Monitor UPS alarm info.
- ◆ Monitor UPS running parameters.
- ◆ Timing off/on setting.

RS-232 communication data format:

Baud rate ----- 2400bps

Byte length ----- 8bit

End bit ----- 1bit

Parity check -----none